

Pacific

PR15-D5

Pump+Reservoir

Pump+Reservoir

This product is intended for installation only by expert users. Please consult with a qualified technician for installation. Improper installation may result in damage to your equipment.

1. Please carefully read the manual before beginning the installation process !
2. It is strongly recommended to use market proven pre-mix coolant, such as Thermaltake Coolant 1000.
3. DO NOT USE any kind of alcohol or alcohol derivatives with this reservoir or the acrylic tube may crack and fail ! Do not clean it using alcohol either !

Parts List

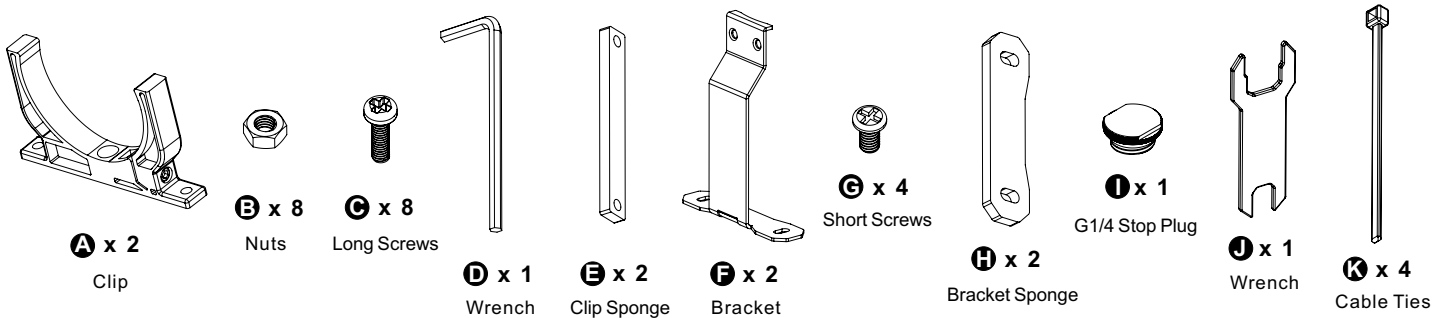

Installation Guide

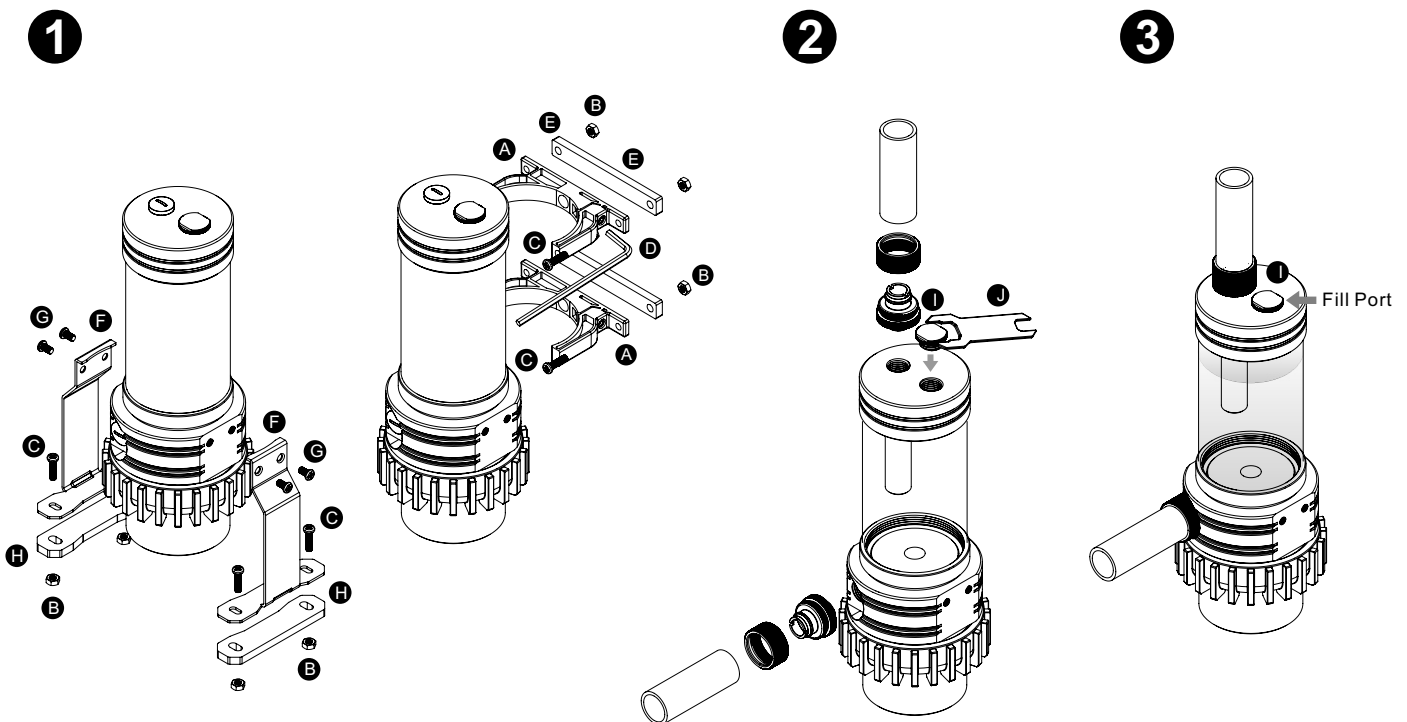

There are two types of mounting kits, please choose the mounting kit you want to use (Both types can be installed together)

Install your fittings and tubes, remember to use the bottom as an outlet and top as an inlet.

After adding the recommended coolant, remember to fill the reservoir to only 80% and leave the fill port cap off. This will help stabilize your internal loop pressure